

Congratulations on your choice!

As the proud owner of this wonderful machine, you can now experience the taste of a delicious cup of espresso or cappuccino in the comfort of your own home.

An empty rectangular box with a thin black border, positioned horizontally in the upper middle section of the page.An empty rectangular box with a thin black border, positioned horizontally in the lower middle section of the page.

F - A (01)

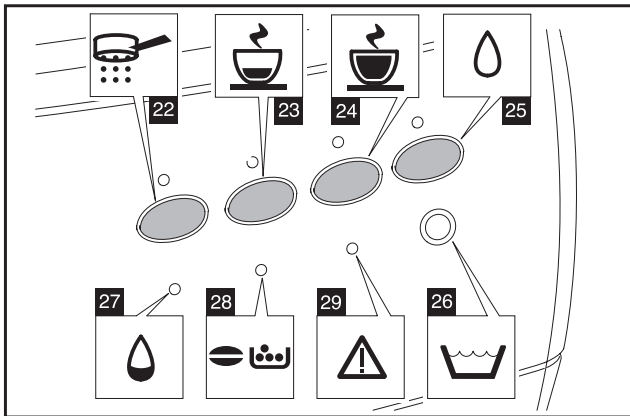
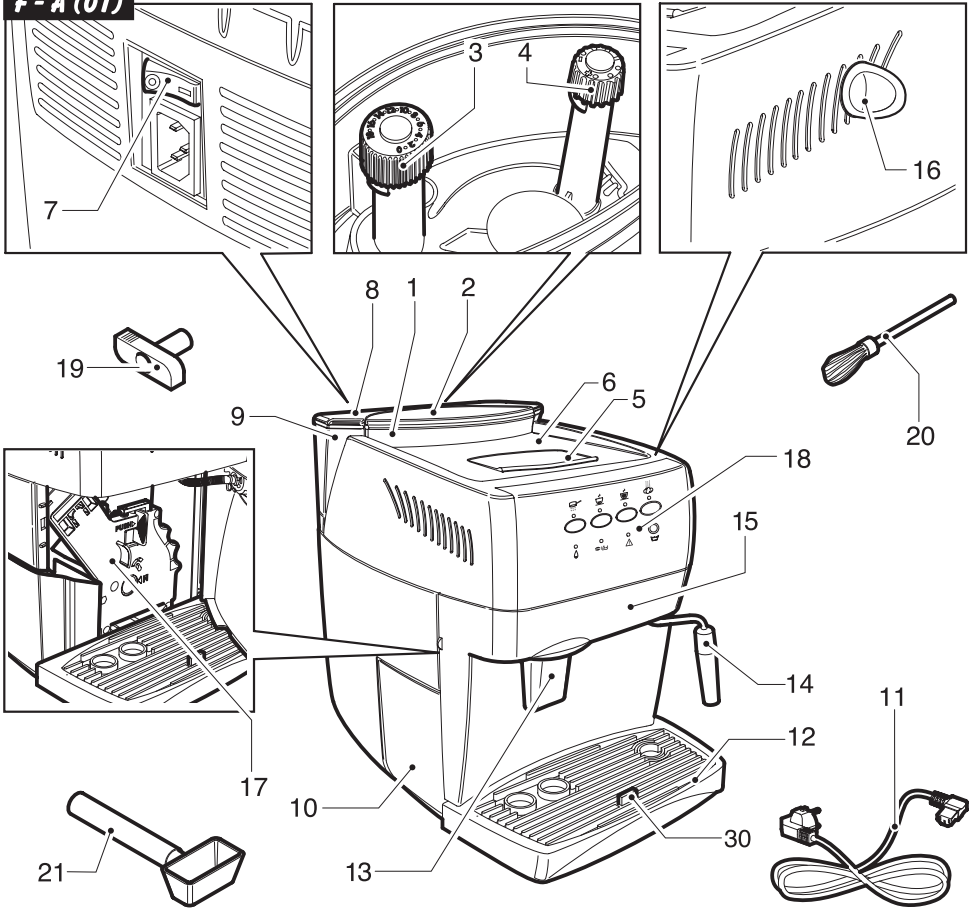

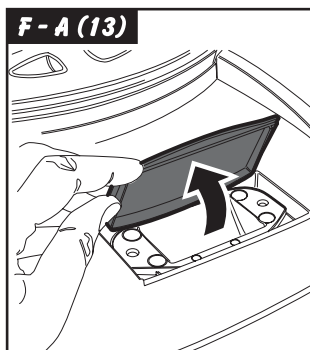
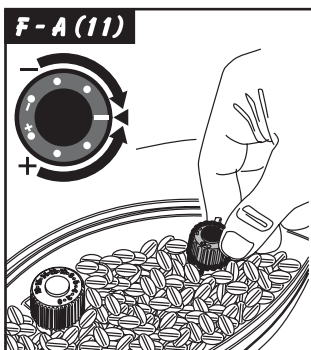
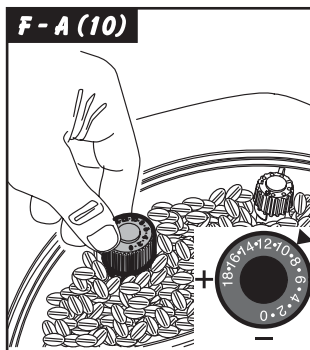
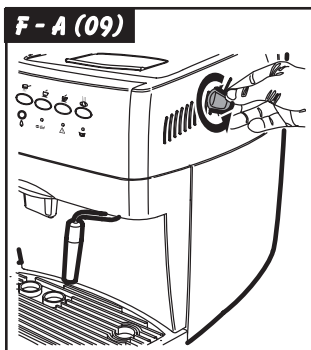
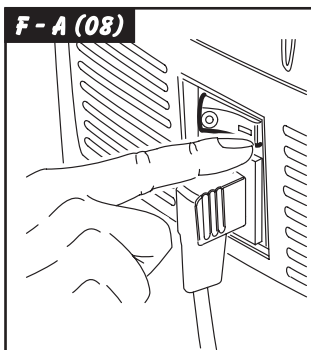
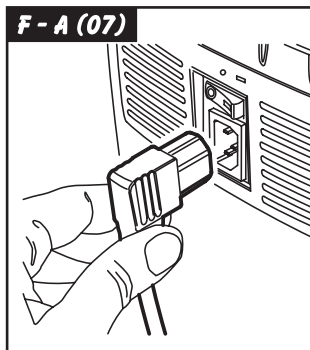
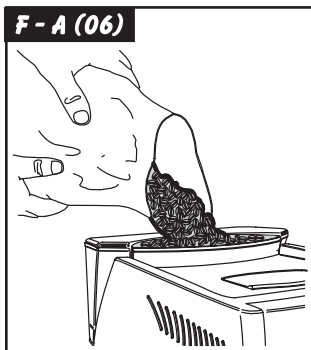
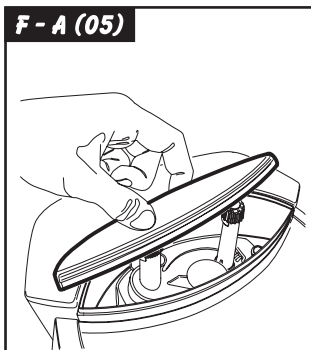
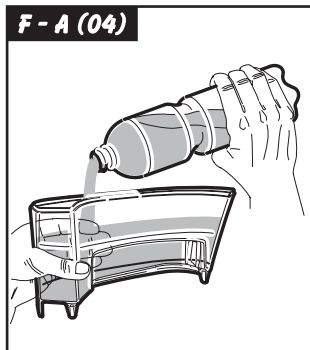
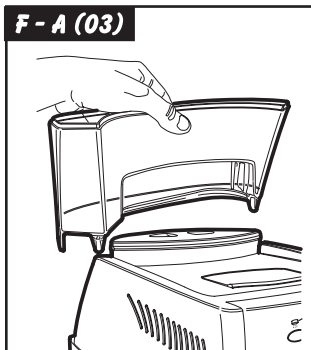
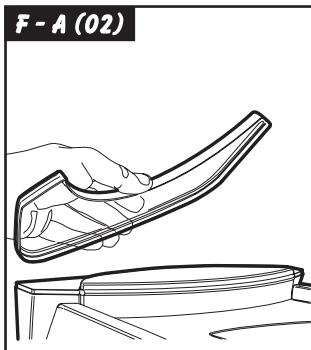

F - A (14)

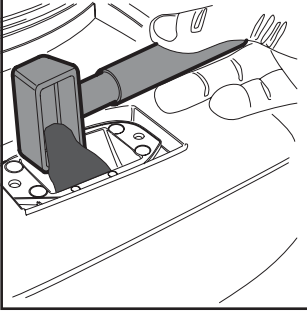

F - A (15)

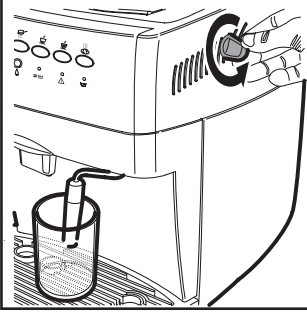

F - A (16)

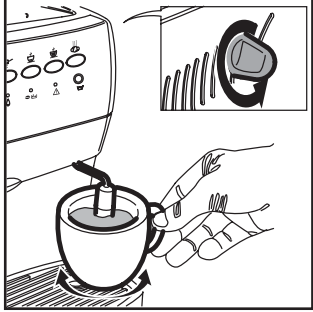

F - A (17)

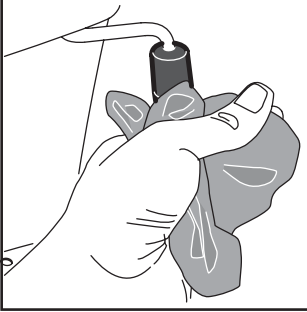

F - A (18)

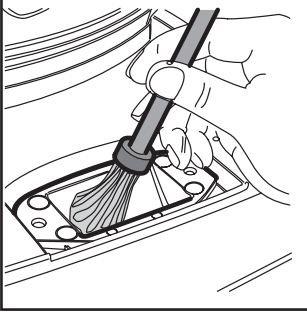

F - A (19)

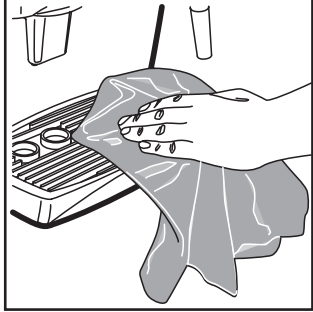

F - A (20)

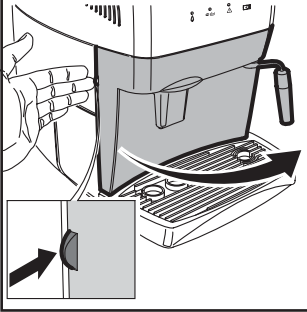

F - A (21)

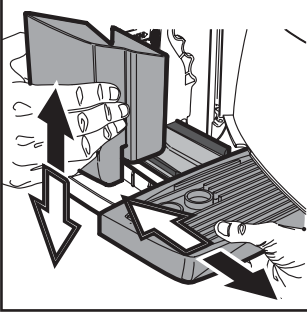

F - A (22)

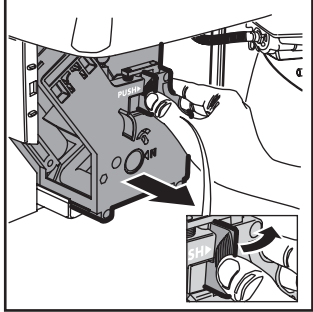

F - A (23)

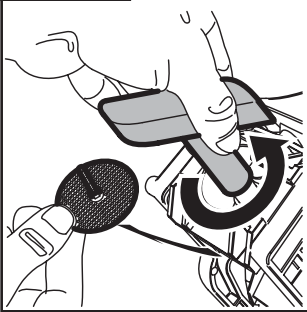

F - A (24)

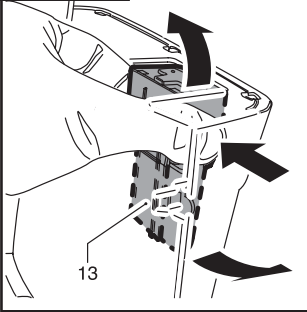

F - A (25)

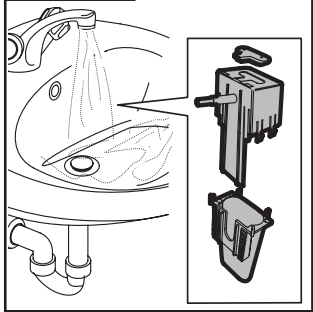

IMPORTANT SAFEGUARDS

When using electrical appliances, basic safety precautions should always be followed to reduce the risk of fire, electric shock, and/or injury to persons, including the following:

- 1 Read all instructions and information in this instruction book and any other literature included in this carton referring to this product before operating or using this appliance.
- 2 Do not touch hot surfaces. Use handles or knobs.
- 3 To protect against fire, electric shock and personal injury do not immerse cord, plugs or appliance in water or other liquid.
- 4 Close supervision is necessary when any appliance is used by or near children.
- 5 Unplug from outlet when not in use and before cleaning. Allow to cool before putting on or taking off parts, and before cleaning the appliance.
- 6 Do not operate any appliance with a damaged cord or plug or after the appliance malfunctions or has been damaged in any way. Return appliance to the nearest authorized service center for examination, repair or adjustment.
- 7 The use of accessory attachments not recommended by the appliance manufacturer may result in fire, electric shock or personal injury.
- 8 Do not use outdoors.
- 9 Do not let cord hang over edge of table or counter, or touch hot surfaces.
- 10 Do not place on or near a hot gas or electric burner, or in a heated oven.
- 11 Always turn appliance OFF, then plug cord into the wall outlet. To disconnect, turn switch to OFF, then remove plug from wall outlet.
- 12 Do not use appliance for other than intended household use.
- 13 Use extreme caution when using hot steam.

CAUTION

This appliance is for household use. Any servicing, other than cleaning and user maintenance, should be performed by an authorized service center. Do not immerse base in water. To reduce the risk of fire or electric shock, do not disassemble the base. There are no user serviceable parts inside. Repair should be done by authorized service personnel only.

- 1 Check voltage to be sure that the voltage indicated on the nameplate agrees with your voltage.
- 2 Never use warm or hot water to fill the water tank. Use cold water only.
- 3 Keep your hands and the cord away from hot parts of the appliance during operation.
- 4 Never clean with scouring powders or hard implements. Simply use a soft cloth dampened with water.
- 5 For optimal taste of your coffee, use purified or filtered water. Your appliance will still need descaling every 2-3 months.

INSTRUCTIONS FOR THE POWER SUPPLY CORD

- A A short power-supply cord is provided to reduce risks of getting tangled up or tripping over a longer cord.
- B Longer extension cords are available and may be used if care is exercised in their use.
- C If a long extension cord is used:
 - 1 the marked electrical rating of the extension cord should be at least as great as the electrical rating of the appliance.
 - 2 if the appliance is of the grounded type, the extension cord should be a grounding type
 - 3 the cable does not hang from the table to avoid the risk of getting caught up in it.

SAVE THESE INSTRUCTIONS



1 GENERALITIES

This coffee maker is designed to make espresso coffee using both coffee beans and preground coffee; it is also equipped with a device for supplying steam and hot water. This elegantly designed appliance has been designed for household use and is not suitable for continuous, professional-type use.

 **Caution:** The manufacturer cannot be held liable for any damages/injury attributable to the following:
 Incorrect use and not in keeping with the indented use.
 Repairs not carried out by authorized service centers.
 Tampering with the supply cord.
 Tampering with any machine part.
 Use of not original spare parts and accessory attachments.
 Limescale and / or freezing damage.

In these cases, the warranty is voided.

1.1 Reading this instruction book

 The following symbols have been used to facilitate reading:
 The caution triangle denotes all instructions important for the safety of the user. Follow these instructions scrupulously to avoid serious injury!

 This symbol denotes information that should be taken into account to get the most out of the appliance.

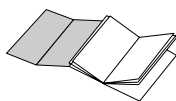

The figures referred to in the text can be found on the cover flap.

Keep these pages open when reading the instructions.

1.2 Using this instruction book

Keep these instructions in a safe place and hand them over to any other person who uses this coffee maker.

For additional information or for information on topics not covered or inadequately covered in this book, contact the authorized service centers.

2 TECHNICAL INFORMATION

Nominal Voltage	See nameplate found on the appliance.
Rated Output	See nameplate found on the appliance.
Material of Body	Thermoplastic (ABS)
Dimensions (l x h x d)	11" x 15.2" x 15.4" / 280 x 385 x 390 mm
Weight	17.6 lbs / 8 kg
Cord Length	4' / 1200 mm
Control Panel	Front
Water tank	Removable
Power Supply	See nameplate found on the appliance.
Water tank	46 oz / 1.3 l
Coffee Container Capacity (Coffee Beans)	8 oz / 230 g
Pump Pressure (bar)	15
Boiler	Aluminium
Safety Devices	Boiler pressure safety valve Safety thermostat

The manufacturer reserves the right to change the make up of the machine in the light of any technological breakthrough.

The machine complies to the European Standard 89/336/EEC (legislative decree 476 04.12.92), referring to the elimination of broadcasting disturbance.

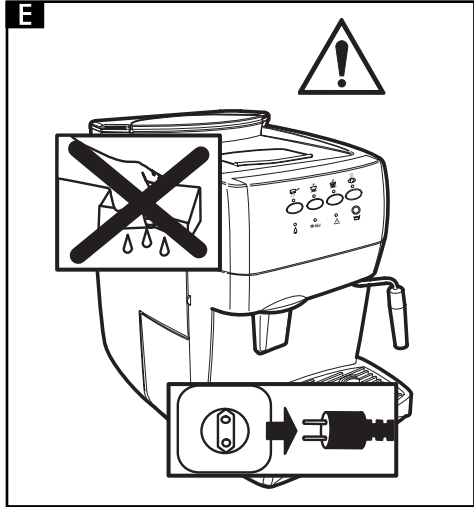
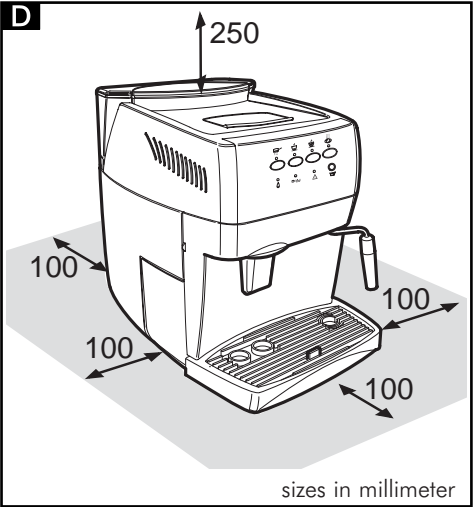
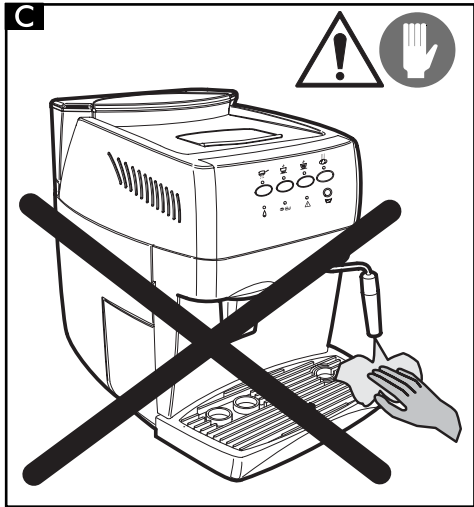
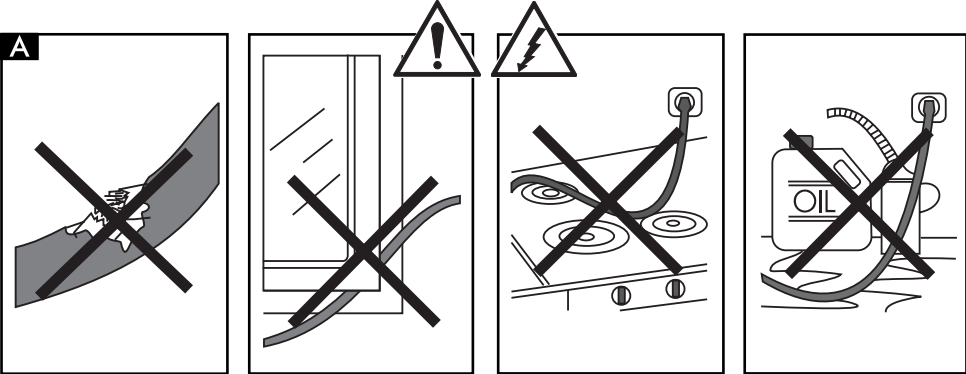

3 SAFETY STANDARDS



Never let live parts come into contact with water: short-circuit hazard! The superheated steam and hot water can cause scalding! Never direct the steam or the hot water jet towards body parts! Touch the steam /hot water nozzle carefully: scalding hazard!

Intended Use

- This coffee maker is intended for household use only.
- Do not make technical changes and use the appliance inappropriately: damage/injury hazard!
- The coffee maker must only be used by adults who are in full control of their mental and physical capacities.

Power Supply

- Connect the coffee maker to a suitable outlet only.
- The voltage must match the one specified on the nameplate of the appliance.

Power Supply Cord (Fig.A)

- Never use the coffee maker if it has a faulty cord.
- The defective cord must be replaced immediately
- An authorized service center must replace the defective cords and plugs immediately
- Do not let the cord touch sharp edges, very hot objects and oily surfaces.
- Do not carry or pull the coffee maker by the cord.
- Do not pull the cable to remove the plug , and do not touch the plug with wet hands or feet.
- Avoid letting the cord dangle from tables or raised surfaces.

Preventing Injury (Fig.B)

- Ensure that the machine is out of the reach of children.

Children are not aware of the risks involved in electrical appliances.

- Do not leave packing material near children.

Scalding Hazard (Fig.C)

- Do not direct the flow of the superheated steam and/or hot water towards yourself and/or others: scalding hazard!
- Always use the correct handles or knobs.
- Do not insert objects through the openings in the appliance.

Space necessary to installation, usage, and maintenance. (Fig.D)

- Place the machine on a flat, even surface.
- The machine must be positioned in a safe place where it cannot be knocked over or cause injury.
- Choose a position that is well-lit, hygienic and where a wall socket is easily accessible.
- To prevent melting or damage to the casing, do not rest the machine on very hot surfaces or near open flames.
- Place the coffee maker 4"/ 10 cm away from walls and cooking tops.
- Do not keep the machine at a temperature below 32 F/0°C; freezing may damage the machine.
- The wall outlet must be reachable at all times.
- Do not use the coffee maker outdoors.

Cleaning (Fig.E)

- Before cleaning the coffee maker, switch the ON/OFF switch (7) to O/OFF; then, remove the plug from the wall outlet.
- Wait for the machine to cool down.
- Never immerse the appliance in water! Avoid splashes.
- Never tamper with the machine inside parts.

Storing the Appliance

- When the appliance is not used regularly , switch OFF the appliance and remove the plug from the wall outlet.
- Store it in a dry place, away from children.
- Protect it from dust and dirt.

ENGLISH

Repairing / Maintenance

- If the coffee maker falls and you see or suspect damages or malfunctions, immediately remove the plug from the wall. Never use faulty machines.
- Repairs must be made by authorized service centers only
- If authorized service centers do not carry out maintenance work and/or repairs, the manufacturer is not liable for any damages.

Fire Fighting

- In the event of a fire, use carbon dioxide extinguishers (CO₂). Do not use water or powder extinguishers.

DESCRIPTION OF PARTS

See Fig.01

- 1 Coffee bean container
- 2 Coffee bean container lid (aroma preserver)
- 3 Grinder control knob
- 4 Dose control knob
- 5 Preground coffee doser lid
- 6 Cup warming surface
- 7 ON- OFF switch
- 8 Water tank lid
- 9 Water tank
- 10 Dump box
- 11 Power cord
- 12 Drip tray + grill
- 13 Height adjustable coffee dispenser
- 14 Steam / hot water nozzle
- 15 Front door
- 16 Steam / hot water knob
- 17 Brew unit
- 18 Control panel
- 19 Brew unit key
- 20 Cleaning brush
- 21 Preground coffee measuring scoop

Control panel

- 22 Preground coffee button /LED
- 23 Espresso coffee button / temperatureready LED
- 24 Long coffee button / temperature ready LED
- 25 Hot water button / LED
- 26 Descale button / LED
- 27 Water warning light
- 28 Our of bean warning light /full dump box warning light
- 29 Malfunction warning light
- 30 Full drip tray float

4 INSTALLING THE COFFEE MAKER

For your safety and the safety of third parties, follow the Safety Standards (see chapter 3).

4.1 Packaging

The original packaging was designed and made to protect the appliance during shipment. We recommend you keep it for future needs.

4.2 Preliminaries

Remove the coffee maker from the packaging and position it in a suitable location that meets the requirements specified and described in the safety standards (chap.3).

Open the machine door, take the drip tray (12) from the package, and fit the dump box (10); then, fit the drip tray in the machine (Fig.21).

Make sure that the drip tray and grill (Fig.01, pos. 12), the dump box (10) and the brew unit (17) are inserted correctly and that the front door (15) is closed.

Keep the cleaning brush (20) and the brew group key (19) handy as you will need them for regular maintenance.

If the red light (29) is still on when the machine is started, it means that one of the parts described above is positioned incorrectly

i Caution: You must read chapter 15. This chapter explains in detail the meaning of all the visual signals displayed to the user through the lights (LEDs) found on the control panel.

4.3 Preparing the coffee maker for use

Remove the water tank lid (Fig.02) and remove the tank (Fig.03). Rinse and fill with fresh water (Fig.04); we recommend that you do not exceed the MAX level mark. Put the water tank back in its place and put the lid on it.

! Always fill the tank (9) with fresh still water. Hot water and other liquids can damage the tank and/or the appliance. Do not operate the appliance without water: make sure that there is enough water inside the tank.

Lift the coffee bean container lid (Fig.05) and fill the contain with coffee beans (Fig.06).

! Use coffee beans only . Ground and instant coffee, as well as other items, cause damage to the appliance.

Put the lid of the coffee bean container (1) back in place.

Insert the plug into the outlet at the back of the coffee maker (Fig.07) after making sure that the ON/OFF switch (7) is in the O/ OFF position.

Insert the other end of the plug into a suitable wall outlet.

When not in use, the ON/OFF switch of the appliance is in the O position. To switch ON the coffee maker, simply press the switch (Fig.08) to the I position. The LEDs (23) and (24) start flashing on the control panel.

To prime the machine, position the steam/hot water nozzle (Fig.01, item 14) over the drip tray and place a cup under the steam nozzle.

Press the hot water button (25) and turn the knob counterclockwise. Wait for water to flow regularly from the nozzle and, then, shut off the flow by turning the knob clockwise.

i Note: You must prime the machine as soon as it is switched ON for the first time, if the machine has not been used for a long time, if the water tank has been emptied completely or if the warning light (27) flashes.

After switching ON the appliance, LEDs (23) and (24) flash simultaneously during the heating phase. Once the heating phase is finished, LEDs (23) and (24) come on steady. At this point, your coffee maker is ready for use. Follow the instructions below to dispense coffee, hot water or steam and use the appliance correctly.

5 THE COFFEE GRINDER (FIG.10)

Caution! Only turn the grinder control knob, found inside the coffee bean container (Fig. 10), when the coffee grinder is working and in increments of 2 settings at a time only. Do not insert ground and/or instant coffee in the coffee bean container. Do not insert anything other than coffee beans in the container. The coffee grinder contains dangerous moving parts; keep fingers and/or other objects away. Before carrying out any operations in the coffee bean container, switch OFF the ON/OFF switch (7) and remove the plug from the wall outlet. Do not insert coffee beans when the coffee grinder is working.

The quality and the taste of your coffee depend not only on the blend you use, but also on the grinder setting.

The appliance comes with a grinder adjustment knob (Fig.10). To use this feature, turn the graduated knob when the coffee grinder is working and in increments of 2. The numbers displayed on the knob indicate the grinder setting. The manufacturer sets the knob to an average grinder setting at the factory: if the ground coffee is too fine, turn the knob toward the higher numbers; if the ground coffee is too coarse, turn the knob toward the lower numbers.

You will notice the change only after brewing three /four cups of coffee.

Use coffee beans for espresso coffee makers. Avoid using extreme grinder positions (e.g. 1 and 16); if this is necessary, try using different coffee blends.

Store the coffee in a cool and dry place, in an airtight container

You should change the grinder position if the coffee does not flow optimally, specifically:
 Too fast = grinding too coarse > grind coffee finer (smaller setting);
 Too slow (drips and/or no flow) = grinding too fine > grind coffee coarser (higher setting).

6 ADJUSTING THE COFFEE DOSE (FIG.11)

You may select the quantity of coffee beans (dose)

that you wish to grind per cup. The manufacturer sets an average dose at the factory

To change the coffee dose, simply turn the knob (Fig. 11) found inside the coffee bean container. Turn it counterclockwise to increase the dose (towards +) and clockwise to decrease the dose (towards -). The - = 6g and + = 9 g.

You must adjust the dose before pressing the desired coffee button.

This system allows you to obtain an optimal cup of coffee with all types of marketed coffee.

7 THE COFFEE DISPENSER

i Note: If the appliance does not dispense coffee, check the water level in the tank.

Before making coffee, make sure that the green temperature-ready LEDs (23) and (24) are on steady and that the water tank and the coffee bean container are full.

Place 1 or 2 coffee cups under the coffee dispenser spouts; you can adjust the height of the dispenser by moving it up or down manually (Fig.12) to adjust the spouts to your cups.

7.1 Making coffee with coffee beans

To dispense the coffee, press the desired coffee button (23) or (24). The selected button starts flashing (see chap.15), while the other switches off

To make 1 cup of coffee, position a single cup under the coffee dispenser spouts and press the button (23) or (24) only once; to make 2 cups of coffee or a double shot, position one or two cups under the spouts and press the button (23) or (24) twice in rapid succession. In this operating mode, the appliance automatically grinds and doses the right quantity of coffee; going through two grinding and dispensing cycles automatically and dispensing 2 cups of coffee or a double shot.

Then, the dispensing cycle starts.

After carrying out the prebrewing cycle, coffee

will start to come out of the spout (Fig.01, pos.13).

The coffee will stop flowing automatically when the preset level is reached (see par.7.3). You can interrupt the flow of coffee by pressing the button (fig.01, pos.23 or 24).

7.2 Making coffee with preground coffee

 In this operating mode, you must use the supplied measuring scoop (Fig.01, pos.21) to dose the preground coffee.

 Only use ground coffee suitable for espresso coffee makers in the doser (5); placing coffee beans, instant coffee and other materials inside the doser causes damage to the appliance.

 Keep fingers away from the preground coffee doser since there are moving parts.

Use the supplied measuring scoop (21) to measure the right quantity of preground coffee to place in the doser.

Use only one level measuring scoop at a time; to make two cups of coffee using preground, you must go through the entire process twice.

Press the button (22) to select the preground function, the LED lights up.

Lift the lid of the preground coffee doser (Fig.13).

Fill one level scoop of preground coffee; discard any excess quantity of ground coffee.

Fill the doser with the preground coffee (Fig.13)

Close the lid of the preground coffee doser.

To make the coffee, press the desired coffee button (23) or (24); the selected button starts flashing (see chapter 15), while the other switches off

The dispensing cycle begins.

After carrying out the prebrewing cycle, coffee will start to come out of the spout (13).

The coffee will stop flowing automatically when the preset level is reached (see par. 7.3).

You can interrupt the flow of coffee by pressing either coffee button (23) or (24).

Then the machine automatically returns to the normal operating mode (see para. 7.1).

7.3 Adjusting the quantity of coffee per cup

Your coffee maker has been programmed to make 2 types of coffee: espresso coffee with the button (23) and long coffee with the button (24). To adjust the programmed values to the size of your cups, place the cup under the coffee dispenser (13), press the button of the desired type of coffee (23) or (24) and keep it pressed. Wait for the machine to fill the cup up to the desired level and, then, release the button.

 Note: keep coffee button (23) or (24) pressed during the entire coffee dispensing process. Maximum level is 8 oz.

In this way, the appliance is reprogrammed to supply the quantity of coffee you selected.

8 DISPENSING HOT WATER

 Caution: splashing may occur at the start - scalding hazard! The hot water nozzle can reach high temperatures: avoid touching directly with your hands.

Before dispensing hot water make sure that the hot water button (25) is activated (light will be on steady).

Proceed as follows when the appliance is ready to dispense hot water:

Place a cup and/or pitcher under the steam/hot water nozzle (Fig.15).

Turn the knob counterclockwise as shown in Fig.15.

When you have obtained the desired quantity of hot water, turn the knob clockwise to shut off the flow. The appliance is immediately ready to brew coffee.

9 DISPENSING STEAM / PREPARING CAPPUCCINO

 Steam can be used to froth milk for cappuccinos and also to heat other beverages.

 Scalding hazard! Splashing may occur at the start - scalding hazard! The hot water nozzle can reach high temperatures: avoid touching

ENGLISH

touching directly with your hands.

This appliance has a Rapid Steam feature which eliminates waiting time between frothing and brewing. Making cappuccinos and lattes has never been this easy!

Before dispensing steam, make sure the hot water button (25) is OFF.

Direct the steam nozzle (14) towards the drip tray and turn the steam/ hot water knob (16). Purge any residual water in the system and close the steam knob as soon as you get a good jet of steam through the nozzle.

Fill a pitcher or a cup 1/3 full with cold milk.

i For best results when making cappuccinos, the milk and the used cup should be cold.

Immerse the steam nozzle 1/4" into the milk to be frothed and turn the steam knob (16) counterclockwise.

Turn the container slowly with up and down movements to make a uniform froth (Fig.16).

Continue steaming until you have the desired amount of froth and the milk is approx.165F hot, then close the steam knob (16).

The same system can be used to heat other beverages.

Clean the steam nozzle with a damp cloth (Fig.17)

9·1 Making coffee after using the steam function

If you want to make more coffee immediately after steaming milk, you can go straight into brewing a cup of coffee. Just press the desired coffee button!

10 CLEANING AND MAINTENANCE

General Cleaning

Maintenance and cleaning should only be carried out when the appliance is cold and disconnected from the power supply

Do not immerse the appliance in water and do not wash any parts in the dishwasher

Do not use abrasives or aggressive chemicals (solvents) for cleaning.

Do not dry the machine and/or any of its parts using a microwave and/or conventional oven.

We recommend you clean the water tank and change the water daily.

Clean the preground coffee doser daily - Use the supplied brush to clean the doser (Fig.18).

To clean the appliance, use a soft cloth dampened with water (Fig.19).

Clean the service area and the brew unit.

We recommend you empty and clean the drip tray (12) and the dump box (10) daily; to carry out this operation you must open the front door (Fig.20) and remove the drip tray (Fig. 21); then, you can empty and clean all the components.

You can remove the coffee dispenser in order to clean it (Fig.24):

- lower the dispensing nozzles
- take the dispensing unit as shown in Fig. 24, and remove it from its housing
- wash the whole unit with warm water

10.1 The brew unit

i The brew unit (17) must be cleaned each time you fill the coffee bean container or at least once a week.

Switch off the appliance by pressing the ON/OFF switch (7) to the O/OFF position and remove the plug from the wall outlet.

Open the service door (15). Remove the drip tray (12) and the dump box.

Remove the brew unit by holding it by its handle and pressing the PUSH button (Fig.22))

Make sure that the stainless steel filter is free from any coffee residue. The top filter can be removed by unscrewing the plastic pin counterclockwise using the specific brew unit key supplied with the machine (Fig.23).

Wash the brew unit only with cold or warm water: do not use detergents. Then thoroughly wash and dry all its components.

Put the filter back on and carefully hand tighten the plastic pin back on using the specific key. Clean the compartment inside the appliance. Holding it by its handle, slide the brew unit back in place until it locks in place.

Insert the dump box, the drip tray and grill back in place. Close the door (15).

Regular lubrication of the brew unit is also recommended. Contact Saeco USA for more information.

11 DESCALING

Limescale / mineral / scale build-up will occur during the lifespan of this appliance. To ensure the longevity of your machine, you should descale it every 2-3 months, or sooner if you notice a reduction in the water flow or when the LED of the button (26) flashes.

 We recommend the Saeco descaler. You can also use any citric based, non-toxic and non-chemical descaler/ decalcifier for these systems.



Caution! Never use vinegar.

To descale the appliance proceed as follows:

Mix the descaler with water as specified on the package and fill the water tank.

Switch ON the appliance with the ON/OFF switch (7).

Press the button (26) for at least 5 seconds to select the descaling operating mode; the LED will come on steady when descaling activated. Direct the steam nozzle (14) toward the drip tray.

Position a large container under the steam nozzle and turn the hot water knob counterclockwise (16). The appliance starts an automatic descaling cycle with pauses preset by the manufacturer and managed

automatically by the appliance.

At the end of the cycle, the flow of the descaling solution is shut off and the 5 buttons start flashing simultaneously.

Turn the knob of the hot water nozzle (16) clockwise to OFF. At this time the warning light (27) flashes.

Rinse the water tank and fill it with fresh water.

Position a large container under the steam nozzle and empty 2/3 of the contents of the water tank by turning the steam knob (16) counterclockwise; to shut off the flow, turn the knob (16) clockwise.

Let the appliance heat up and empty the remaining contents of the water tank by pressing the hot water button (25) and turning steam knob (16) counterclockwise; to stop flow, turn it clockwise.

 If you use a descaling/ decalcifying product other than Saeco's, follow the manufacturer's directions on the package to mix the right quantity of product/ water. Then descale as described above.

 If the descaling cycle is interrupted by switching the machine OFF, it will continue when the machine is switched back ON. You must finish the descaling cycle.

12 FUNCTION PROGRAMMING

The appliance allows you to program some parameters depending on your needs.

To program the functions, you must enter the programming mode as follows:

Ensure that the ON/OFF switch (7) of the appliance is switched to O/OFF and that the hot water / steam knob (16) is OFF.

Press the buttons (23) and (25) and, at the same time, switch ON the appliance using the ON/OFF switch (7).

You are now in the programming mode.

To quit the programming mode and implement your changes, switch the machine OFF and, then, back ON again using the main switch (7).

ENGLISH

12.1 Programming water hardness

Water hardness varies, depending on the area and type of water used. This coffee maker can be adjusted so that it will work optimally with the water hardness level, expressed on a scale from 1 to 4, of your area.

The appliance is already set to an average value (hardness 3).

 Before proceeding, you must check the water hardness of your area using the strip supplied with the appliance. Quickly immerse (1 second) the strip into the water and shake slightly. After a minute, the strip shows the test results.

To program this function, proceed as follows:

Press the button (22); the number of lit buttons indicates the programmed water hardness; If you desire to change the water hardness level, press the button (22) repeatedly until the correct number of lit buttons are displayed, indicating the water hardness level. If in doubt, program to a higher water hardness.

Hardness 1 = buttons (22) and (23) lit

Hardness 2 = buttons (22), (23) and (24) lit

Hardness 3 = buttons (22), (23), (24) and (25) lit

Hardness 4 = buttons (22), (23), (24), (25) and (26) lit

The hardness index matches the 1-4 squares on the strip.

12.2 Programming the rinsing cycle

When first switched ON, the machine will carry out an automatic rinsing cycle. Approx. 3-4 oz of water are dispensed through the system and out through the coffee dispenser to ensure you get fresh water for your first cup of coffee.

To program this function, proceed as follows: Press the button (23); when the function is ON, the warning light (27) lights up.

12.3 Programming Prebrewing

The prebrewing process slightly dampens the coffee before brewing to improve the extraction; this brings out the full aroma of the coffee and gives it an excellent taste.

To program this function, proceed as follows:

Press the button (24); when the function is ON, the warning light (28) lights up.

 Note: the manufacturer has already activated this function.

12.4 Programming Pregrinding

The pregrinding procedure makes the machine grind twice: the first time, for the cup of coffee just selected, and then, for the next cup of coffee (not yet selected). This function is only useful when preparing numerous cups of coffee in rapid succession (for example, during a dinner party) as you always have a dose of ground coffee ready to go.

To program this function, proceed as follows:

Press the button (25); when the function is ON, the warning light (29) lights up.

13 LEGAL INFORMATION

This instruction book contains the necessary information to use and upkeep your appliance correctly

The information should be viewed as a guideline to use and upkeep your coffee maker in safety. The information is not exhaustive. For additional information or for information on topics not covered or inadequately covered in this book, please contact the authorized service centers or the manufacturer directly

In addition, we should mention that these instructions are not a part of a previous or existing agreement, legal contract or similar and that the information is not changed by any other document.

All the manufacturer's obligations and liabilities are based on the relative sale contract that also specifies all warranty terms and conditions.

The contractual warranty terms and conditions are not limited or extended based on this instruction book.

This instruction book contains information protected by copyright.

This instruction book cannot be photocopied or translated into other languages without the explicit written consent of the manufacturer.

14 SCRAPPING

Make unusable any appliances not in use.

Detach the plug from the wall outlet and cut the electric cord.

Deliver broken appliances to a suitable collection center.

15 CONTROL PANEL LEDS

GREEN LED (22)

- Appliance ready to brew with preground coffee
-

GREEN LED (23), FIXED

GREEN LED (24), FIXED SIMULTANEOUSLY

- Temperature-ready:
To dispense coffee
To dispense hot water or steam (depending on which function selected LED 25)
-

GREEN LED (23), FLASHING

GREEN LED (24), FLASHING SIMULTANEOUSLY

- Appliance is heating up to dispense coffee, hot water or steam
-

GREEN LED (23), SLOW FLASHING

- Appliance dispensing 1 espresso coffee
-

GREEN LED (23), FAST FLASHING

- Appliance dispensing 2 espresso coffees
-

GREEN LED (24), SLOW FLASHING

- Appliance dispensing 1 long coffee
-

GREEN LED (24), FAST FLASHING

- Appliance dispensing 2 long coffees
-

GREEN LED (25), FIXED

- Hot water function selected. To prime machine or dispense hot water.
-

GREEN LED (25), OFF

- Steam function selected.
-

RED LED (26), FLASHING

- The appliance needs a descaling cycle
Descal as described in par . 11.
To cancel the selection, press another buttonkeeping the knob tuned OFF.
-

RED LED (26), FIXED

- The descaling function has been selected
To descale as described in par. 11, turn the hot water knob (16) counterclockwise.
Descaling cycle must be completed before machine is ready to brew coffee.
-

RED WARNING LIGHT (27), FIXED

- Insufficient quantity of water in the water tank

Fill the tank with fresh water and prime the machine.

If the light doesn't clear, check the grey plastic float in the water tank. If missing or sinking to bottom, contact an authorized service center for replacement float.

RED WARNING LIGHT (27), FLASHING

- The machine needs to be primed.

Prime the machine (section 4.3)

RED WARNING LIGHT (28), FIXED

- The coffee bean container is empty

Fill the container with coffee beans and press the coffee button again.

RED WARNING LIGHT (28), FLASHING

- The dump box is full or cup count on machine is telling machine dump box is full.

**You must empty the dump box while the unit is ON.

RED WARNING LIGHT (29), FIXED

- Incorrectly positioned brew unit, drip tray and/ or front door.

The fixed red light goes off when all the components are correctly positioned or closed.

RED WARNING LIGHT (29), FLASHING

- The coffee grinder motor is blocked
- Brew unit motor shutdown.

Contact an authorized service center.



** Caution: The dump box must only be emptied when the appliance is ON. Remove for at least 5 seconds and then put back in place. Machine has cup count on it to signal when the dump box is full. If you empty it while the machine is OFF, the machine will not reset the counter and you will not be able to brew coffee.